

## Mortise push/pull hardware

## HL6 Mortise

## Mortise push/pull hardware

The HL6 with mortise hardware combines the features and convenience of the HL6 push/pull operation with the Schlage L Series heavy-duty mortise lock. The added functionality is particularly useful in areas where locking or electrified access is required.



## Features and benefits

- Quiet functionality
- 16 mortise functions, including electrified and thumbturn options
- Five mounting positions
- 10 finishes, including antimicrobial options
- Seven available options, including request-to-exit and engraving on handles
- Two strike options
- Non-handed
- UL Listed for all single labeled metal or wood doors

## Dimensions

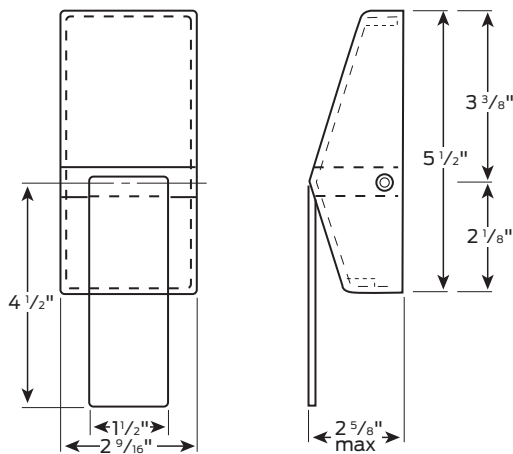

## HL6 Mortise exit trim

Using the Von Duprin 9875/9975 mortise exit device, along with Schlage HL6 push/pull trim, Allegion has created an exit device with mortise lock durability and ADA compliance. Consult the Von Duprin 98/99 catalog for complete product information.

## Functions legend

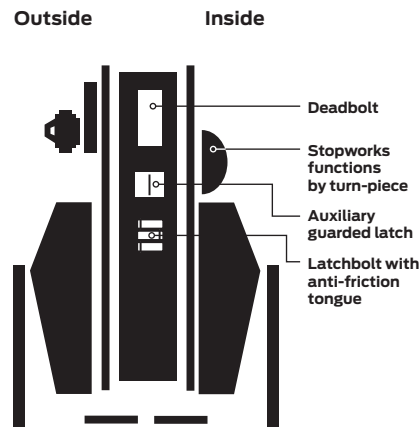



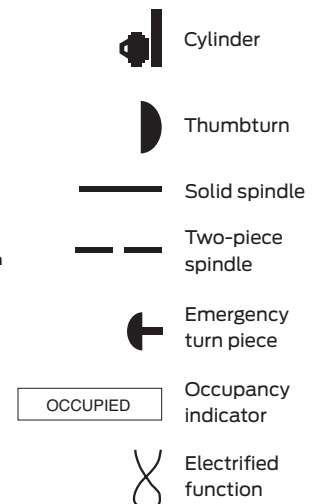





## Functions key











## Mortise hardware functions

## HL6 mortise

Schlage <b>HL6-9010</b> <b>Passage lock</b> <ul style="list-style-type: none"> <li>• Latchbolt retracted by paddle from either side at all times</li> <li>• Inside paddle always free for immediate egress</li> </ul> 	ANSI <b>F01</b>	Schlage <b>HL6-9040</b> <b>Bath/bedroom privacy lock</b> <ul style="list-style-type: none"> <li>• Latchbolt retracted by paddle from either side unless outside lever is locked by inside thumbturn</li> <li>• Actuating inside paddle or closing door unlocks outside paddle</li> <li>• To unlock from outside remove emergency button, insert emergency thumbturn (furnished) in access hole and rotate</li> <li>• Inside paddle always free for immediate egress</li> </ul> 	ANSI <b>F22</b>	Schlage <b>HL6-9050</b> <b>Entrance/office lock</b> <ul style="list-style-type: none"> <li>• Latchbolt retracted by paddle from either side unless outside paddle is made inoperative by key or thumbturn</li> <li>• With outside locked, latchbolt retracted by key or inside paddle</li> <li>• Outside paddle locked until unlocked by thumbturn or key</li> <li>• Auxiliary latch deadlocks latchbolt when door is closed</li> <li>• Inside paddle always free for immediate egress</li> </ul> 	ANSI <b>F04</b>	Schlage <b>HL6-9060</b> <b>Apartment entrance lock</b> <ul style="list-style-type: none"> <li>• Latchbolt retracted by paddle from either side unless outside is locked by key from inside</li> <li>• When locked, latchbolt retracted by key or inside paddle</li> <li>• Auxiliary latch deadlocks latchbolt when door is closed</li> <li>• Inside paddle always free for immediate egress</li> </ul> 	ANSI <b>F09</b>
Schlage <b>HL6-9070</b> <b>Classroom lock</b> <ul style="list-style-type: none"> <li>• Latchbolt retracted by paddle from either side unless outside paddle is locked by key</li> <li>• Unlocked from outside by key</li> <li>• Auxiliary latch deadlocks latchbolt when door is closed</li> <li>• Inside paddle always free for immediate egress</li> </ul> 	ANSI <b>F05</b>	Schlage <b>HL6-9080</b> <b>Storeroom lock</b> <ul style="list-style-type: none"> <li>• Latchbolt retracted by paddle inside or key outside</li> <li>• Outside paddle always inoperative</li> <li>• Auxiliary latch deadlocks latchbolt when door is closed</li> <li>• Inside paddle always free for immediate egress</li> </ul> 	ANSI <b>F07</b>	Schlage <b>HL6-9082</b> <b>Institution lock</b> <ul style="list-style-type: none"> <li>• Latchbolt retracted by key from either side</li> <li>• Paddle on both sides always inoperative</li> <li>• Auxiliary latch deadlocks latchbolt when door is closed</li> </ul> 	ANSI <b>F30</b>	Schlage <b>HL6-9092EL</b> <b>HL6-9092EU</b> <b>Electrically locking/unlocking outside paddle, outside cylinder (replaces HL6-9080EL/EU)</b> <ul style="list-style-type: none"> <li>• Outside paddle continuously locked (EL) or unlocked (EU) by 12V or 24V DC</li> <li>• Latchbolt retracted by paddle inside or key outside</li> <li>• Auxiliary latch deadlocks latchbolt when door is closed</li> <li>• Inside paddle always free for immediate egress</li> <li>• EL: Switch or power failure allows outside lever to retract latchbolt</li> <li>• EU: Switch or power failure locks (EU) outside lever</li> </ul> 	ANSI <b>—</b>

## Mortise hardware functions

## HL6 mortise

Schlage	ANSI	Schlage	ANSI	Schlage	ANSI	Schlage	ANSI
<b>HL6-9095EL</b> <b>HL6-9095EU</b> <b>Electrically locked or electrically unlocked both sides, inside and outside cylinder</b> <ul style="list-style-type: none"> <li>Both paddles continuously locked (EL) or unlocked (EU) by 12V or 24V DC</li> <li>Latchbolt retracted by either key</li> <li>Auxiliary latch deadlocks latchbolt when door is closed</li> <li>EL: Switch or power failure unlocks both paddles and allows paddle to retract latchbolt</li> <li>EU: Switch or power failure locks both paddles</li> </ul> 	—	<b>HL6-9453</b> <b>F20</b> <b>Entrance/office lock with deadbolt</b> <ul style="list-style-type: none"> <li>Latchbolt retracted by paddle from either side unless outside locked by 20° thumbturn rotation</li> <li>Deadbolt actuation through 90° thumbturn rotation</li> <li>When locked, outside key or inside paddle retracts both deadbolt and latchbolt</li> <li>Outside paddle locked until thumbturn is restored to vertical position</li> <li>Throwing deadbolt locks outside paddle</li> <li>Auxiliary latch deadlocks latchbolt when door is closed</li> <li>Inside paddle always free for immediate egress</li> </ul> 	F20	<b>HL6-9456</b> <b>F13</b> <b>Corridor lock</b> <ul style="list-style-type: none"> <li>Latchbolt retracted by paddle from either side</li> <li>Deadbolt actuation by key or thumbturn rotation</li> <li>Throwing deadbolt locks outside paddle</li> <li>Actuating inside paddle retracts both deadbolt and latchbolt and unlocks outside paddle</li> <li>Inside paddle always free for immediate egress</li> </ul> 	F13	<b>HL6-9465</b> <b>—</b> <b>Closet/storeroom lock</b> <ul style="list-style-type: none"> <li>Latchbolt retracted by paddle from either side</li> <li>Deadbolt actuation by key</li> </ul> 	—
<b>HL6-9466</b> <b>F14</b> <b>Store/utility room lock with deadbolt</b> <ul style="list-style-type: none"> <li>Latchbolt retracted by paddle from either side</li> <li>Deadbolt actuated by either key</li> </ul> 	F14	<b>HL6-9473</b> <b>F21</b> <b>Dormitory/bedroom lock</b> <ul style="list-style-type: none"> <li>Latchbolt retracted by paddle from either side</li> <li>Deadbolt actuation by outside key or inside thumbturn</li> </ul> 	F21	<b>HL6-9485</b> <b>—</b> <b>Faculty/hotel/restroom lock</b> <ul style="list-style-type: none"> <li>Latchbolt retracted by outside key or inside paddle</li> <li>Outside paddle always fixed</li> <li>Deadbolt actuation by thumbturn</li> <li>All keys (except emergency and display keys) inoperative when deadbolt is thrown</li> <li>Inside paddle retracts both deadbolt and latchbolt</li> <li>Auxiliary latch deadlocks latchbolt when door is closed</li> <li>Inside lever always free for immediate egress</li> </ul> 	—	<b>HL6-9486</b> <b>—</b> <b>Faculty/hotel/restroom lock with legacy indicator</b> <ul style="list-style-type: none"> <li>Adds 09-611 "DO NOT DISTURB" indicator to HL6-9485</li> <li>Specify L583-375 for "OCCUPIED"</li> <li>When deadbolt is thrown indicator message is displayed and all keys (except emergency and display keys) become inoperative</li> </ul> 	—